



Front Load Washer & Heat Pump Dryer COMBINATION

SAFETY INFORMATION 2

USING THE COMBO

Getting Started 4

Consumer Help Indicator 17

Appliance Communication 17

Loading 18

CARE AND CLEANING 19

INSTALLATION INSTRUCTIONS 22

TROUBLESHOOTING TIPS 27

LIMITED WARRANTY 34

CONSUMER SUPPORT 36

OWNER'S GUIDE & INSTALLATION INSTRUCTIONS

PFQ97HS

ENGLISH/ESPAÑOL

Write the model number, serial number and MAC ID for WiFi enabled models here:

Model # _____

Serial # _____

You can find them on a label on the front panel below the gasket.

FRANÇAIS

Pour une version français de ce manuel d'utilisation, veuillez visiter notre site web à l'adresse GEAppliances.com.

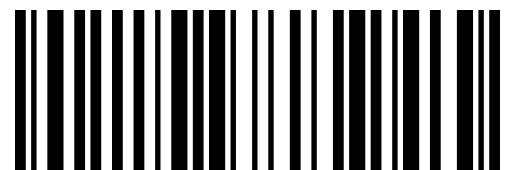

IMPORTANT SAFETY INFORMATION

READ ALL INSTRUCTIONS BEFORE USING THE APPLIANCE

⚠ WARNING

Sharp Edges – Although it is unnecessary to perform this type of maintenance, to reduce the risk of injury, use care when cleaning the condenser or evaporator coil fins.

Proper Disposal of your Appliance

- Dispose of or recycle your appliance in accordance with Federal and Local Regulations. Contact your local authorities for the environmentally safe disposal or recycling of your appliance.

PROPER INSTALLATION

This Combo must be properly installed and located in accordance with the Installation Instructions before it is used.

- Ensure that the hot water hose is connected to the “H” valve and the cold water hose is connected to the “C” valve.
- Install or store where it will not be exposed to temperatures below freezing or exposed to the weather, which could cause permanent damage and invalidate the warranty.
- Properly ground unit to conform with all governing codes and ordinances. Outlet receptacle must be supplied by an Individual, properly polarized and grounded 15 or 20 amp circuit breaker or time-delay fuse. Follow details in the Installation Instructions.
- Ensure unit is properly leveled and unit legs are adjusted such that unit is stable.
- GE Appliances strongly recommends the use of factory specified parts. A list of factory hoses available for purchase are listed. These hoses are manufactured and tested to meet GE Appliances specifications.
- GE Appliances strongly recommends the use of new water supply hoses. Hoses degrade over time and need to be replaced every 5 years to reduce the risk of hose failures and water damage.
- Consider recycling options for your appliance packaging material.

AUTOMATIC DRAIN SEQUENCE

- Machine will automatically drain any time the door is left open for more than 15 minutes and water is present.
- Machine will automatically drain if left in a paused state with the door closed for more than 24 hours and water is present.

WHEN NOT IN USE

- Turn off water faucets to minimize leakage if a break or rupture should occur. Check the condition of the fill hoses; GE Appliances recommends changing the hoses every 5 years.

PARTS AND ACCESSORIES

Order on-line at GEApplianceparts.com today, 24 hours a day or by phone at 877.959.8688 during normal business hours. In Canada, visit your local GE Appliances parts distributor or call 800.661.1616 or GEAppliances.ca/en/products/parts-filters-accessories.

Part Number	Accessory	Part Number	Accessory
WX14X10011	6 ft stainless steel washer hoses with 90° elbows; 2-pack	WX08X10070	4" Duct Vent Cap
WH49X316	Unit drain hose extension kit - Approximately 44"	PM14X10056	Appliance Brush Set
WH41X36697	Unicouple Hose Assembly for Clothes Washer	PM7X2	Universal low profile washer floor tray - White
GFAPC120V (or equivalent)	4 Prong 240V to 110V Plug Converter	GFR0728	28" width Riser without drawer
		NOTE:	The 28" width tall pedestal with drawer is not advised for use with the Combo.

READ AND SAVE THESE INSTRUCTIONS

Getting started

Throughout this manual, features and appearance may vary from your model.

⚠ WARNING To reduce the risk of fire, electric shock, or injury to persons, read the **IMPORTANT SAFETY INFORMATION** before operating this appliance.

2 **No load transfer! Start a load before work, before you go to bed...or anytime!**
 When you choose **WASH + DRY**, your work is done. The Combo will wash and then gently dry your garments in just a couple hours, so you can go about your business. Finally, laundry is one and done.

Clothes may feel a little damp when the dry cycle ends, but they're actually dry!
 Because your Combo dries clothes at low heat in a sealed drum, they may feel slightly damp or cool on first touch. Just take them out and shake them out and they will feel dry in a few seconds.

Wash + Dry a load in just a couple hours. Times may adjust before and during cycles.
 Your Combo learns your load patterns, fabric types and habits. You may notice that the total cycle time will adjust during a cycle and from load to load based on load size, soil level and spin out after wash.

Easy access dual-stage lint filter ensures high efficiency airflow.
 Recirculating filtered, high speed air-flow allows the Combo to deliver great drying performance. You'll notice that less lint is generated through air tumbling versus standard dryers. Look for reminders to clean the filter.

Simple to use with plenty of options! Explore all the features.
 Don't mess with detergent & softener: **SmartDispense**. Reduce wrinkles at end of cycle: **Wrinkle Care**.
 Start the Combo from your phone: **Remote Start**. ¿No hablas inglés?: Cambiar **Language** en el **Menu**.
 Increase dryness level of your laundry: **More Dry**. Toss in a dryer sheet: **Wash Complete** 🔔 notifies when.

1 Power On the Combo and load it with sorted laundry items.

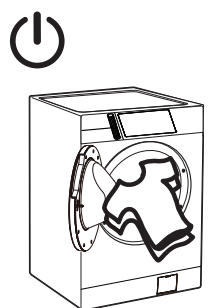

2 Check the filter on both sides. To get the best drying efficiency, it is important to start with a clean filter.

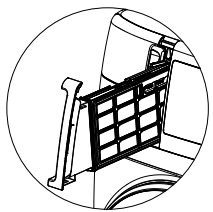

3 Select a Wash + Dry cycle. If desired, you can choose to run a Wash or Dry only.

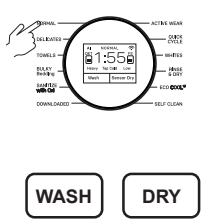

4 Manually dose or use SmartDispense after filling with detergent and/ or softener. Choose other Wash and Dry Options as desired.

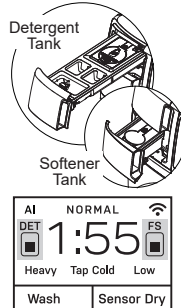

5 When ready, tap the Start / Pause button and let the Combo do the washing and drying thanks to no load transfer.

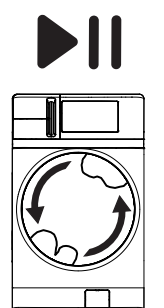

6 If desired, check the SmartHQ App on your phone for notifications, to adjust options, add more dry time or to learn more about the Combo.



SmartHQ App Enabled

There are several options that support your WiFi connected Combo available through the SmartHQ App.

Not only does this App enable you to receive over the air upgrades and updates to your Combo's software, but it unlocks special features for your Combo.



Getting started

Display and Status Lights

(Features and appearance will vary)

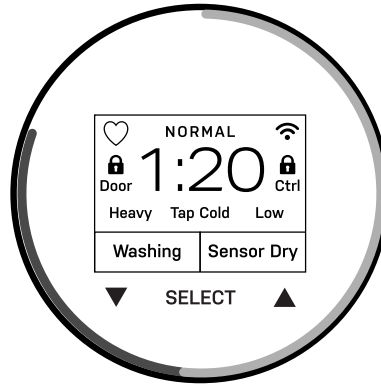







The display shows the cycle options selected, the approximate time remaining until the end of the cycle and the cycle status for **WASH** and **DRY** modes (PreWashing, Washing, Rinsing, Spinning, Drying, Complete).

NOTE: The cycle time is affected by how long it takes the Combo to fill, based on the water pressure in your home. Cycle time is also adjusted based on potential rebalances which may be required to thoroughly spin out the wet load. And finally, for cycles with **DRY** added, the Combo will adjust the drying time to achieve the desired final moisture content.

If an out-of-balance condition is detected by the Combo, the **Spin** status light or **Spin** option selection light will blink during the remaining portion of the cycle and will stay illuminated for a short time after cycle completion. When this occurs, the Combo is taking actions to correct the out-of-balance condition and complete the cycle normally. In some cases, the Combo may not be able to balance the load and spin up to full speed. If you notice the load is more wet than usual at the end of the wash portion of the cycle, redistribute the load evenly in the wash basket and run a **Rinse & Dry** cycle.

The **LIGHT RING** will show a single LED next to the cycle you have selected until you start the cycle. It will then show a representative countdown of the total cycle with the left half in blue tracing the wash cycle and the right half in magenta tracing the dry cycle. In addition, the **LIGHT RING** may indicate actions to remind you to perform maintenance, show signal cycle completion, WiFi set-up or warning messages.

In addition, the display will show:

 (WiFi)	Will allow your appliance to communicate with your smartphone for remote appliance monitoring, control and notifications. It stays lit whenever the Combo is on and is connected.
 Ctrl	The controls on the Combo are locked when this icon is illuminated. You must press and hold the Control Lock button to unlock the controls.
 Door	This icon will illuminate while the door is locked and will blink while the Combo is in the process of pausing and then unlocking.
	This icon indicates that you are using your MySettings options for the cycle selected. MySettings for a cycle can be set by choosing a cycle, selecting your preferred options and then pressing and holding the cycle name again. In the future, simply select that cycle and your MySettings will be instantly recalled. If the heart icon has the letters "AI" inside (), that means the Combo has automatically programmed the MySettings for that particular cycle based on your frequently chosen options.
 DET	Detergent will automatically dose from the SmartDispense - Detergent dispenser according to the weight and soil level of the clothes and brand of product selected. You can adjust this feature to dose MORE or LESS detergent or turn it OFF to manually dose.
 FS	Fabric softener will automatically dose from the SmartDispense - Softener dispenser according to the weight of the clothes and brand of product selected. You can adjust this feature to dose MORE or LESS fabric softener or turn it OFF to manually dose.

Getting started

Features and appearance will vary.

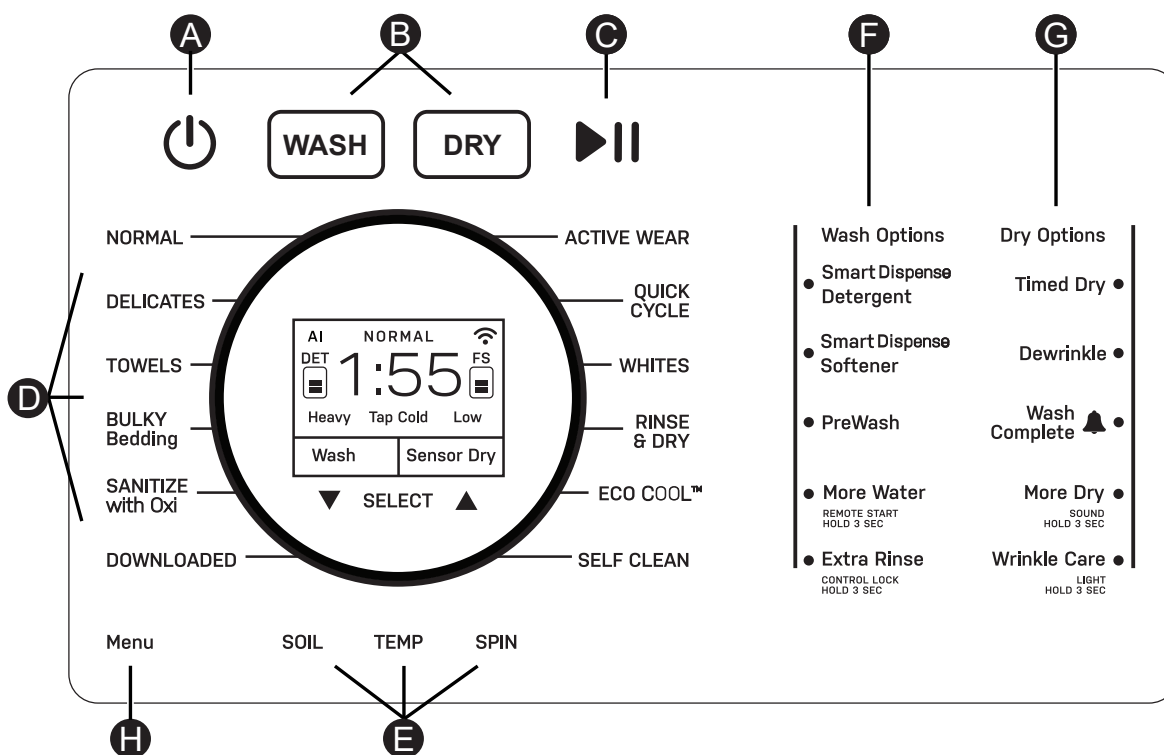

A Power - Press to “wake up” the display. If the display is active, press to put the Combo into standby “OFF” mode.
NOTE: Pressing **Power** does not disconnect the appliance from the power supply.

B WASH and DRY - By default, the Combo selects a complete **WASH** and **DRY** for each cycle. You can choose to run a **WASH** only by deselecting the **DRY** button. Vice versa, you can choose to run a **DRY** only cycle by deselecting the **WASH** button. If you start a **WASH** only cycle, you can always add **DRY** prior to the completion of the cycle.

C Start and Pause - Press to start a cycle. If the Combo is running, pressing it once will pause the Combo and unlock the door. It may take a few seconds for the door to unlock after pressing **Pause**. Press again to restart the cycle.

NOTE: If the Combo is paused with the door open and the cycle is not restarted within 15 minutes, the current cycle will be canceled. If the Combo is paused with the door closed and the cycle is not restarted within 24 hours, the current cycle will be canceled. In both cases, the Combo will drain the water in the tub after the cycle is canceled.

NOTE: The Combo will perform automatic system checks after pressing the **Start** button. Water will flow in 45 seconds or less. You may hear the door lock and unlock and the pump activate before water flows.





D Cycles - The cycles are designed for specific types of wash loads. The chart below will help you match the items to be washed with the best cycle settings. For optimal performance, select the cycle that most closely matches the items being washed. **Delay Start/Remote Start** is available on all cycles.

When **DRY** is also selected, the Combo will deliver a low temperature **Sensor Dry** for the garments in the load after it has completed the tailored wash cycle. The drying process for all cycles are similar to each other as they are for a **DRY** only operation.

Getting started

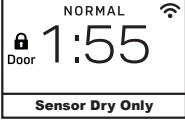
D Cycles (Continued)

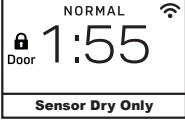
Storing **My Settings** favorite options: To save settings for any cycle, press and hold the cycle name after adjusting the Combo to your desired options and before you hit **Start**. That will store your favorite settings and you will see a heart icon at the top left of the display at that time and whenever that cycle is selected in the future. This will now be your stored **My Settings** for that cycle unless you choose to store new settings by pressing and holding that cycle name again.

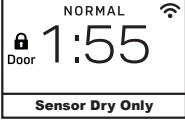
Cycle	Recommended Items		
Normal	Cycle for normal, regular, or typical use for washing or drying up to a full load of normally soiled cotton clothing.		
	<table border="1" style="width: 100%;"> <tr> <td style="width: 50%;"> NOTE: Washer ENERGY STAR® certification is tested on the NORMAL cycle - WASH (Wash Only) and SOIL level default normal. </td> <td style="width: 50%;"> NOTE: Dryer ENERGY STAR certification is tested on the NORMAL cycle - DRY (Sensor Dry Only) and Eco Dry default off. </td> </tr> </table>	NOTE: Washer ENERGY STAR ® certification is tested on the NORMAL cycle - WASH (Wash Only) and SOIL level default normal.	NOTE: Dryer ENERGY STAR certification is tested on the NORMAL cycle - DRY (Sensor Dry Only) and Eco Dry default off.
	NOTE: Washer ENERGY STAR ® certification is tested on the NORMAL cycle - WASH (Wash Only) and SOIL level default normal.	NOTE: Dryer ENERGY STAR certification is tested on the NORMAL cycle - DRY (Sensor Dry Only) and Eco Dry default off.	
<table border="1" style="width: 100%;"> <tr> <td style="width: 50%; text-align: center;">  </td> <td style="width: 50%; text-align: center;">  </td> </tr> </table>			
			
NOTE: Energy savings will vary across loads and cycles.			
Delicates	Lingerie and special care fabrics with light soil.		
Towels	Towels, sheets, pillowcases and dish rags.		
Bulky Bedding	Comforters, large coats, bed spreads, mattress covers, sleeping bags, and similar large bulky items.		
Sanitize With Oxi	Heavily soiled colorfast items with the need for sanitization. Cannot be used for Sensor Dry Only or Timed Dry Only cycle.		
Active Wear	Medium to lightly soiled athletic wear items of technical or synthetic fabrics.		
Quick Cycle	Small loads of lightly soiled items that are needed in a hurry.		
Whites	Whites and household linens.		
Rinse and Dry	For items that need only to be rinsed and not washed. This cycle gives you two versions when Dry is selected: Rinse & Dry or Drain & Dry (when Extra Rinse is deselected). It gives you two additional versions when Dry is deselected: Rinse & Spin , or Drain & Spin (Extra Rinse deselected). A spin is always performed unless you select No Spin .		
Eco Cool	Cycle for normal, regular, or typical use for washing up to a full load of normally soiled cotton clothing using only cold water while delivering equivalent performance to Normal Warm wash.		
Downloaded	Use the SmartHQ App to download a specialty cycle for your Combo.		
Power Clean*	For heavily soiled items which require extra cleaning power.		
Jeans*	Jeans with medium to light soil.		
Swim Wear*	Swim wear with medium to light soil.		
Air Fluff*	Provides 15 minutes (to up to 4 hours, if desired) of tumbling time with recycled filtered air and no heat.		
Dewrinkle	A cycle designed to reduce wrinkles from a small load that is dry or slightly damp.		
Self Clean	Cleaning the basket of residue and odor. No clothes are to be washed using this cycle.		

NOTES:

The **SANITIZE with Oxi** cycle's water temperatures CANNOT be changed. This cycle, when using an Oxi additive along with your detergent, is designed to remove 99% of bacteria found in home laundry. Measure the detergent and the Oxi products carefully. Using the amounts appropriate for a large heavily soiled load in a front load unit, follow the detergent and the Oxi product label instructions. The Combo's hot water supply connection must provide a minimum of 120°F to ensure the effectiveness of this cycle.

The **WASH** portion of the **SANITIZE with Oxi** cycle has been designed and tested per **NSF Protocol P172** to meet the requirements of sanitizing effectiveness.

*Available through **Downloaded** cycles.

The ENERGY STAR® name and mark are registered trademarks owned by the U.S. EPA.

Getting started

D Cycles - Continued

The cycles are optimized for specific types of loads. The chart below will help you match the items to be laundered with the best cycle settings. For optimal performance, select the cycle that most closely matches the items in your load. **Delay Start/Remote Start** is available on all cycles.

		Wash Cycles															
		Normal	Delicates	Towels	Bulky Items	Active Wear	Quick Cycle	Whites	Rinse and Dry	Eco Cool	Power Clean*	Jeans*	Swim Wear*	San. w/Oxi †	Air Fluff††	Dewrinkle ‡	Self Clean
Wash Settings	Soil Level																
	Extra Heavy	•		•	•	•		•		•	•	•	•	•			
	Heavy	•		•	•	•		•		•	•	•	•	•			
	Normal	•	•	•	•	•	•	•		•	•	•	•	•			
	Light	•	•	•	•	•	•	•		•		•	•				
	Extra Light	•	•	•	•	•	•	•		•		•	•				
	Wash Temperature																
	Extra Hot	•						•			•			•			
	Hot	•	•		•			•			•		•				
	Warm	•	•	•	•	•	•	•			•	•	•	•			
	Cold	•	•	•	•	•	•	•			•	•	•	•			
	Tap Cold	•	•	•	•	•	•	•			•	•	•	•			
	Spin Selection																
	Ex High (Max)	•		•	•		•	•	•	•	•	•	•		•		
	High	•		•	•		•	•	•	•	•	•	•		•		
	Medium	•	•	•	•	•	•	•	•	•	•	•	•	•	•		
	Low		•	•	•	•	•	•	•	•	•	•	•	•	•		
No Spin		•			•			•					•				
Wash Options																	
SmartDispense™ - Detergent	•	•	•	•	•	•	•		•	•	•	•	•	•			
SmartDispense™ - Softener	•	•	•	•	•	•	•		•	•	•	•	•	•			
Prewash	•	•	•	•	•		•		•	•	•	•	•	•			
More Water	○	•	•	•	•	•	•		•	•		•	•				
Extra Rinse	•	•	•	•	•	•	•	•	•	•	•	•	•	•			
Dry Settings																	
Dry Options																	
Sensor Dry	•	•	•	•	•	•	•	•	•	•	•	•	•	•			
Timed Dry	•	•	•	•	•	•	•	•	•	•	•	•	•	•	•	•	
Wash Complete	•	•	•	•	•	•	•	•	•	•	•	•	•	•			
More Dry**	•	•	•	•	•	•	•	•	•	•	•	•	•	•			
Wrinkle Care	•	•	•	•	•	•	•	•	•	•	•	•	•	•	•	•	

This cycle is for periodic cleaning of the Combo only. See the **Self Clean** section for more information.

• Available setting

Factory default setting

* Available from Downloaded cycles.

○ Available on **WASH + DRY**, but not **WASH** only.

** Not available when **Timed Dry** is selected.

† Available on **WASH + DRY** and **WASH** only. Not available on **Sensor Dry Only** or **Timed Dry Only**.

‡ **Timed Dry Only** cycle.

Getting started

E Settings

Individual settings for soil level (**SOIL**), water temperature (**TEMP**) and spin speed (**SPIN**) can be set from the minimum to maximum. Changes made using these buttons are shown in the LCD display just below the cycle time. These settings only apply to the **WASH** portion of the cycle and have no impact on drying.

SOIL

Changing the **SOIL** level increases or decreases the wash time to remove different amounts of soil.

To change the **SOIL** level, press the **SOIL** level button until you have reached the desired setting. You can choose between **Extra Light**, **Light**, **Normal**, **Heavy** or **Extra Heavy** soil levels on most cycles.

TEMP

Adjust to select the proper water temperature for the cycle.

Follow the fabric manufacturer's care label when selecting the wash temperature.

To change the wash temperature, press the **TEMP** button until you have reached the desired setting. You can choose between **Tap Cold**, **Cold**, **Warm**, **Hot** or **Extra Hot** on most cycles. By design, to protect fabrics, not all wash temperatures are available for certain cycles. **Extra Hot** will use 100% hot water from your water supply. The Combo does not heat the water.

These settings apply to the **WASH** portions of the cycle only. The **TEMP** settings select the water temperature in **WASH** and do not change the air temperature for **DRY**.

The **PreWash** rinse water is always cold to help reduce energy usage and reduce setting of stains and wrinkles.

NOTE: The first 10 seconds of the wash fill is always cold. This feature assists in conditioning the fabric and preventing stains from setting on garments.

SPIN

Adjusting the **SPIN** speed changes the final spin speed of the wash portion of the cycle. Always follow the garment manufacturer's care label when changing the **SPIN** speed.

To change the **SPIN** speed, press the **SPIN** speed button until you have reached the desired setting. You can choose between **No Spin**, **Low**, **Medium**, **High** or **Max**. Higher spin speeds are not available on certain cycles, such as **DELICATES** and **ACTIVE WEAR**.

Higher spin speeds remove more water from the clothes and will help reduce dry time, but may also increase the possibility of setting wrinkles on some fabrics.

NOTE: The Combo will still do a **SPIN** if **DRY** is requested on a **WASH** cycle in which **NO SPIN** is selected.

NOTE: This Combo features a **dBTM (Dynamic Balancing Technology)** system. This patented onboard sensing technology enables real-time balancing of the spin cycle for each load, saving time and providing a quiet wash. This should lead to more consistent wash times and an overall reduction in noise and vibration. If the Combo should experience any excessive noise, vibration or shaking, simply **Pause** the Combo, open the door, and manually redistribute the load before restarting the cycle.

Getting started

F Wash Options

SmartDispense™ - Detergent

When selected, this feature will automatically add detergent to the wash based on the load size, eliminating the need to add detergent for each load. Multi-tapping this button will step through dosing levels of **AUTO**, **MORE**, and **LESS** (levels visualized on the LCD screen and the LED indicator next to the button will be ON) and **OFF** (level shows off on the LCD and the LED indicator will be off). The Combo also has **Adaptive SmartDispense** capability through the SmarHq App. With this enhancement, you can select the specific type of detergent and, in addition to using load size information, it will adjust the dosage based on the detergent manufacturer's recommendations. See the **SmartDispense - Detergent** section for details.

SmartDispense™ - Softener

When selected, this feature will automatically add softener to the final rinse based on the load size, eliminating the need to add softener for each load. Multi-tapping this button will step through dosing levels of **AUTO**, **MORE**, and **LESS** (levels visualized on the LCD and the LED indicator will be ON) and **OFF** (level shows off on the LCD and the LED indicator will be off). The Combo also has **Adaptive SmartDispense** capability through the SmarHq App. With this enhancement, you can select the specific type of softener and, in addition to using load size information, it will adjust the dosage based on the softener manufacturer's recommendations. See the **SmartDispense - Softener** section for details.

PreWash

Prewash is an extra wash before the main wash. Use it for heavily soiled clothes or for clothes with a care label that recommends prewashing before washing.

NOTE: Detergent from **PreWash** can only use detergent from the **SmartDispense** detergent tank. SmartDispense will automatically add the proper amount of detergent for prewash based on the load size. If you choose to deselect **SmartDispense** detergent to support a manual detergent dose, the **PreWash** cannot be activated.

PreWash must be selected prior to pressing **Start**.

The **PreWash** feature will fill the Combo (adding the prewash detergent), tumble the clothes, drain and spin. Then the Combo will run the selected cycle.

NOTE: In some special cycles, **PreWash** is selected automatically as the default. You can turn off this selection at any time. The main wash will use new detergent from either the manual detergent compartment or from the **SmartDispense** tank if **SmartDispense** is selected. If you activate it, do not add additional detergent.

More Water

This option adds up to approximately 3 gallons to the wash and rinse portions of the cycle. If the option is selected before the cycle starts, the water will be added from the beginning of the cycle and later to the rinse. If the option is selected during the wash portion, more water will be added at this point and later to the rinse. Likewise, if the **More Water** option is selected after the wash portion has completed, the Combo will add more water to the rinse only. If wash and rinse have completed, the **More Water** button will no longer be active.

Remote Start

After choosing the cycle and the desired options, press and hold for 3 seconds the **More Water/Remote Start** button to allow the Combo to start a cycle from the SmarHq app. The LCD screen will show a purple box as the first sequence before the blue WASH and /or magenta DRY operations for that cycle to indicate that the Combo will await your command to begin the cycle. It is important to hit the **Start/Pause** button to confirm that you want to activate **Remote Start** fully. You will hear the drain pump pulse twice and the door locking to indicate that the Combo is synchronized with the App.

To cancel **Remote Start**, you can either press and hold the **More Water/Remote Start** button once again or Power Off the Combo.

Remote Start can also be initiated from with the **Menu** under the **Delay Start** item by turning it **On** from there.

Extra Rinse

This option allows for an extra rinse during a cycle to remove excess dirt and detergent from soiled loads. Press the **Extra Rinse** button to select.

Getting started

F Wash Options (Continued)

Control Lock

You can lock the controls to prevent any selections from being made. Or you can lock or unlock the controls after you have started a cycle. Children cannot accidentally start the Combo by touching buttons with this option selected.

To lock/unlock the Combo controls, press and hold the **Control Lock** button for 3 seconds. It is accessed through the **Extra Rinse** button with this press and hold action. A sound is made to indicate the lock/unlock status. The control lock icon on the display will light up when it is on.

NOTE: The **Power** button can still be used when **Control Lock** is active.

G Dry Options

Timed Dry (toggles OFF Sensor Dry)

By default, the Combo will always use the Sensor Dry function whenever **DRY** is selected as part of a cycle. Sensor Dry will end the drying cycle when the Combo detects that your clothes are dry. You can choose to select a timed dry instead, by selecting the **Timed Dry** option. **NOTE:** Since you are choosing the exact drying time, the cycle will end at the prescribed time regardless of the dryness level of your load.

Use the ▲ and ▼ buttons under the LCD screen to adjust the dry times in 15 minute increments. Adjustments can be made at any time during the cycle.

Dewrinkle

The **Dewrinkle** feature is a dedicated 35 minute **Timed Dry** cycle that introduces a small amount of water vapor onto the garments and uses heat and high speed air to assist with dewrinkling the garments. It is designed for loads of 1 to 8 light to medium weight garments. There is some minimal benefit for larger loads.

Wash Complete

To receive an audible alert at the machine and via the SmarthQ App (if connected) when the **WASH** portion of the cycle is complete and before proceeding to **DRY**, select the **Wash Complete**  feature. This feature provides you the opportunity to check on the load, remove certain items or add a dryer sheet before the drying portion of the cycle commences. The machine will proceed directly into drying within a few minutes after sounding this alert regardless of whether you choose to pause and restart the cycle.

More Dry

Select this option to extend drying time by 20 minutes at the end of **Sensor Dry** to achieve a greater degree of dryness for the load. This option can be stored as part of **MySettings** for every cycle if you prefer this level of dryness.

Sound

You can turn the button tones and indicator sounds **ON** and **OFF** by pressing and holding the **More Dry/Sound** button for 3 seconds. The **Sound** level can be adjusted from inside the **Menu**.

Wrinkle Care

Select this option to tumble clothes at the end of a cycle. For a **WASH** only cycle, the clothes will tumble intermittently for a period of 8 hours to keep the clothes fresher and less prone to setting in wrinkles. For a **WASH** and **DRY** or for a **DRY** only cycle, **Wrinkle Care** will tumble the clothes intermittently without heat for 8 hours to keep the clothes fresher and less prone to setting in wrinkles.

While the Combo is running in this mode, you can either turn **OFF** or **Pause** the machine to unlock the door and remove the garments. However, you cannot restart **Wrinkle Care** after taking those actions.

Light

The basket light will turn on and remain on for 5 minutes when the door opens or by pressing and holding the **Light** button for 3 seconds.

The **Light** button is accessed by pressing and holding the **Wrinkle Care** button for 3 seconds. Pressing any button during the cycle will temporarily turn on the basket light for your convenience for 30 seconds.

Getting started

Ⓜ Menu Options

⊖ Back	
Detergent	Good
Softener	Good
AI Active	On
Animations	On
Brightness	High
Delay Start	⊖
Eco Dry	Off
Help	⊖
Language	English
Sound Level	Low
Wash/Dry Times	On
Wi-Fi	Connected

Detergent

This displays the **SmartDispense - Detergent** tank level status. The status options are **Good**, **Low**, or **Empty**. If the status is **Low**, the estimated number of loads left before **Empty** is shown.

Softener

This displays the **SmartDispense - Softener** tank level status. The status options are **Good**, **Low**, or **Empty**. If the status is **Low**, the estimated number of loads left before **Empty** is shown.

AI Active

Turn this feature on to enable certain AI features, like **Adaptive MySettings**, or as other AI features become available. **Adaptive MySettings** will learn your laundry habits and automatically create **MySettings** for the cycles and options you use frequently. Turning this feature **OFF** will allow only manual **MySettings** to be created in future occurrences.

Animations

Turn GE Profile welcome and goodbye screen animations on or off.

Brightness

Adjust the brightness of the display. Select either **High**, **Medium** or **Low**.

Delay Start

Select to delay the start of a wash cycle for up to 24 hours or Remote Start the Combo from your smartphone by using the SmartHQ App and enabling the **Time Delay/Remote Start** feature.

- **Time Delay:** Select **Time Delay** to delay the start of a cycle for up to 24 hours. Use the arrows to adjust the delay hours and then press **Select** to set. Use the arrows again to adjust the delay minutes in 15 minute increments and then press **Select** to set. The desired delay time will be shown. Select **Time Delay** again to turn off.
- **Remote Start:** If you have connected your Combo to WiFi, you can enable remote starting of your washer from the GE Appliances Smartphone App. Use this option to toggle the feature on or off. This feature can also be enabled directly by using the **More Water/Remote Start** button on the control panel.

Eco Dry

Turn this feature **On** from within the **Menu** to reduce the total cycle time for the purpose of using less total energy in drying. Turning **On** this feature will cause your items to be less dry at the end of the cycle as compared to when this feature is turned **Off**. By default, this feature is **Off**.

Getting started

H Menu Options (cont.)

Help

Open this submenu to get information and display QR codes to link to product literature, access on-line technical support content, or to learn about advanced features.

Language

Change the language of the display to either **English**, **Spanish**, or **French**.

Sound Level

Adjust the loudness of the end of cycle signal and button volume. Select either **High**, **Low**, or **Off**.

Wash/Dry Times

Toggling this feature **On** will enable the LCD to display the estimated time remaining for **Wash** and **Dry** separately in the color bar for **Wash** and **Dry**. The total estimated cycle time remaining for the cycle will always be shown in the main display.

WiFi

The factory setting for the WiFi is **Off**. You can turn it **On** or **Off** from the **Menu** or during the Welcome process when setting up your Combo. The WiFi feature allows you to set-up or reset your WiFi connection to the unit. It will indicate "Connected" if you have properly configured your Combo for your home network.

Getting started

Dispenser Drawers - Overview

Your Combo is equipped with two SmartDispense drawers. The top drawer can be used for the manual dosing of detergent, bleach and fabric softener. The rear compartment of the top drawer can store up to 50 oz of liquid detergent for SmartDispense detergent dosing. The bottom drawer is used for SmartDispense dosing of fabric softener and can store up to 32 oz of liquid softeners.

For every wash cycle, regardless of whether or not you activate SmartDispense on the controls, the manual compartments will be used and flushed with clean water. Therefore, if you plan to use Smart Dispense detergent and/or softener, you should not fill the detergent and/or softener manual compartments.

NOTE: Bleach, powder detergents and sanitizing rinse aids can only be dispensed manually.

Dispenser Drawer

Slowly open the dispenser drawer by pulling it out until it stops. After adding laundry products, slowly close the dispenser drawer. Closing the drawer too quickly could result in early dispensing of the bleach, fabric softener or detergent.

You may see water in the detergent, bleach and fabric softener compartments at the end of the cycle. This is a result of the flushing/siphoning action and is part of the normal operation of the Combo.

DO NOT put detergent packets in the dispenser drawer.

NOTE: Use only liquid or powder HE detergents and additives in the dispenser drawer. Laundry detergent packets should only be added directly to the wash basket following the manufacturer's directions.

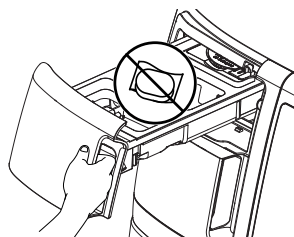

Use only HE High-Efficiency detergent



SmartDispense - Detergent

When selected, this feature will automatically add detergent to the wash, eliminating the need to add detergent for each load.

The detergent amount selection on the control panel will default to **AUTO** when first powering up the Combo. When **AUTO** is selected, the amount of detergent needed for each laundry load will automatically be determined based on the size of the load the machine senses.

For **AUTO**, the Combo will dispense approximately 1.5 oz of detergent for an 8 lb normal load. For other loads, it will adjust proportionally based on the size of load and garment type. If you select **LESS**, the amount of detergent will be reduced by 40% from the default **AUTO** level. This may be desired for higher concentrate detergents or if you have very soft water. For heavily soiled loads, you may want to select **MORE** to add 40% more detergent than the default **AUTO** level. You can set the brand/type of detergent in the SmartHQ App so that the Combo can make adjustments based on detergent manufacturers' recommendations. These manufacturers' settings will tailor the adjustments used for **AUTO**, **MORE** and **LESS** dosing amounts.

NOTE: Not all cycles will allow the use of the **SmartDispense - Detergent** feature. If the light is not illuminated and pressing the **SmartDispense - Detergent** button results in a beeping tone, then SmartDispense is not allowed for the cycle that has been selected. Detergent will need to be added directly to the detergent compartment for these cycles.

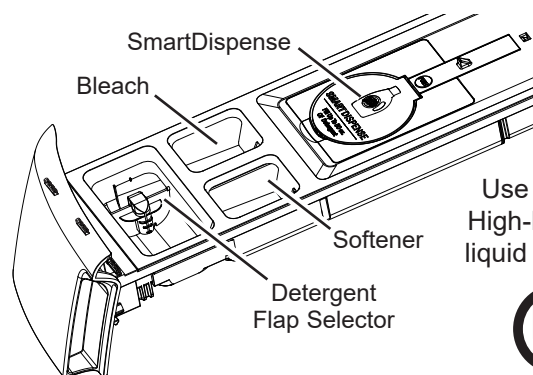

Use only HE High-Efficiency liquid detergent



If it is desired to manually add detergent for a particular load:

1. Press the **SmartDispense - Detergent** button on the control panel until its light turns off which indicates the **SmartDispense** feature has been turned off.
2. Set the flap in the detergent compartment to the type of detergent to be used - Powder or Liquid. See the **Detergent Compartment** section.
3. Add the desired amount of detergent into the detergent compartment.

If the display indicates that the SmartDispense tank is estimating there is insufficient detergent to wash a load, the LCD screen will warn you. The Combo can still run a cycle, but it is suggested that you add detergent in the manual detergent compartment or refill the SmartDispense tank.

Getting started

SmartDispense - Softener

When selected, this feature will automatically add fabric softener to the final rinse, eliminating the need to add fabric softener for each load.

The fabric softener amount selection on the control panel will default to **AUTO** when first powering up the Combo. When **AUTO** is selected, the amount of fabric softener needed for each laundry load will automatically be determined based on the size of the load the machine senses.

For **AUTO**, the Combo will dispense approximately .85 oz of fabric softener for an 8 lb normal load. For other loads, it will adjust proportionally based on the size of load and garment type. If you select **LESS**, the amount of fabric softener will be reduced by 10% - 20% from the default **AUTO** level. This may be desired for higher concentrate fabric softener or if you have very soft water. For heavily soiled loads, you may want to select **MORE** to add 20% more fabric softener than the default **AUTO** level. You can set the brand/type of fabric softener in the SmartHQ App so that the Combo can make adjustments based on fabric softener manufacturers' recommendations. These manufacturers' settings will tailor the adjustments used for **AUTO**, **MORE** and **LESS** dosing amounts.

NOTE: Not all cycles will allow the use of the **SmartDispense - Softener** feature. If the light is not illuminated and pressing the **SmartDispense - Softener** button results in a beeping tone, then SmartDispense is not allowed for the cycle that has been selected. Fabric softener will need to be added directly to the fabric softener compartment for these cycles.

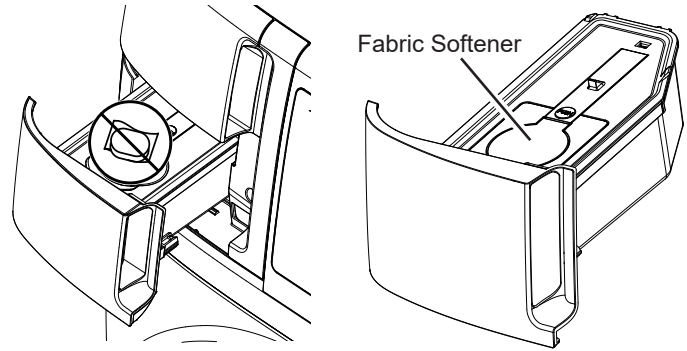

If it is desired to manually add fabric softener for a particular load:

1. Press the **SmartDispense - Softener** button on the control panel until its light turns off which indicates the **SmartDispense - Softener** feature has been turned off.
2. Manually add the desired amount of fabric softener into the fabric softener compartment in the top **dispenser drawer**.

If the display indicates that the **SmartDispense - Softener** tank is estimating there is insufficient fabric softener to wash a load, the LCD screen will warn you. The Combo can still run a cycle, but it is suggested that you add fabric softener in the manual fabric softener compartment or refill the **SmartDispense - Softener** tank.

Do **NOT** put detergent packets in the **SmartDispense - Softener** drawer.

Use only liquid fabric softener in the **SmartDispense - Softener** drawer.

NOTE: Do not pour fabric softener directly on the wash load.

Getting started

Detergent Compartment - Manual Dose (Top Dispenser Drawer)

Only use high-efficiency detergent in this Combo. Do **NOT** fill high-efficiency detergent over the **MAX** line. Use detergent manufacturer's recommended amount.

- **Powder Detergent** – Lift the flap up for powder detergent. This must be done to dissolve and flush detergent properly. Follow the detergent manufacturer's instructions when measuring the amount of powder detergent to use.
- **Liquid Detergent** – Keep the flap down for liquid detergent. This retains the liquid detergent until it automatically flushes at the start of the cycle. Follow the detergent manufacturer's instructions when measuring the amount of liquid detergent to use.

Detergent usage may need to be adjusted for water temperature, water hardness, size and soil level of the load. Avoid using too much detergent in your Combo as it can lead to oversudsing, detergent residue being left on the clothes, and could extend wash times.

Do not put clumped detergent in the dispenser. Clumped detergent can cause a leak.

Do **NOT** put detergent packets in the dispenser drawer.

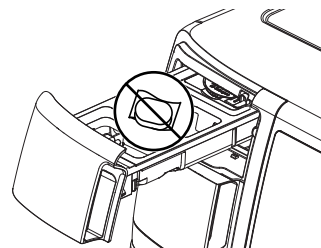

Liquid Bleach Compartment - Manual Dose (Top Dispenser Drawer)

If desired, measure out the recommended amount of liquid bleach, not to exceed 1/3 cup (80 ml) and pour into the compartment labeled "LIQUID BLEACH" marked with this symbol .

It is recommended to use High-Efficiency (HE) bleach in this front-load unit.

Do not exceed the maximum fill line. Overfilling can cause early dispensing of the bleach which could result in damaged clothes.

NOTE: Do not use powdered bleach or laundry detergent/additive packets in the dispenser.

Fabric Softener Compartment - Manual Dose (Top Dispenser Drawer)

If desired, pour the recommended amount of liquid fabric softener into the compartment labeled "FABRIC SOFTENER".

Use only liquid fabric softener in the dispenser.

Do not exceed the maximum fill line. Overfilling can cause early dispensing of the fabric softener, which could stain clothes.

NOTE: Do not pour fabric softener directly on the wash load.

NOTE: The fabric softener compartment will be siphoned in the final rinse of the wash cycle. This compartment can also be used to accommodate other liquid rinse aids such as sanitizers and fabric enhancing liquids. The use of these other products must be certified by the liquid manufacturer for safety in the use of a residential washing machine and combination washer/dryer. Please check carefully, as certain liquids may invalidate the warranty on your Combo.

Consumer Help Indicator

Your Combo is equipped with Consumer Help Indicator (CHI). CHI is our way to communicate a simple remedy for some situations that you can perform without the need to call for service. The chart below describes the helpful messages you may notice scrolling on your display when you return to start another load. These messages will provide simple remedies you can quickly perform.

Spin light blinking	If an out-of-balance condition is detected by the Combo, the Spin light will blink during the remaining portion of the cycle and will stay illuminated for a short time after cycle completion. When this occurs, the Combo is taking actions to correct the out-of-balance condition and complete the cycle normally. In some cases, the Combo may not be able to balance the load and spin up to full speed. If you notice the load is more wet than normal at the end of the cycle, redistribute the load evenly in the wash basket and run a Drain & Spin cycle. (See Rinse & Dry cycle description in the Getting Started - Options section for details.)
“Confirm H2O Supply is ON” (Water not entering Combo)	Check your house water supply. Did you forget to turn on one or both supply valves after installation or coming back from vacation? As soon as the message appears to scroll, the Combo will initiate a 4 minute lock-out period. The Combo controls won't respond/change during this time. After the 4 minutes, you can begin your cycle again. If you try to bypass the lock-out period by unplugging the Combo, the 4 minute timer will start over again.
“Cycle Canceled Draining”	“Cycle Canceled Draining” may show on the display if the machine was paused for longer than 24 hours or if the machine has stopped itself before the cycle completed due to certain errors. As soon as the message appears, the Combo will initiate a 4 minute lock-out period. The Combo controls won't respond/change during this time. After the 4 minute period, you can begin your cycle again. If you try to bypass the lock-out period by unplugging the Combo, the 4 minute timer will start over again. If the problem persists, call GE Appliances at 800.GE.CARES (800.432.2737) for service.
“DOOR OPEN”	“DOOR OPEN” will be shown on the display if you try to start a cycle when the door is not fully closed. The Combo will not start another cycle until the door is fully closed.
“Check and Clean Drain Pump Filter”	“Check and Clean Drain Pump Filter” will display when the Combo detects a restriction in the drain area that is the result of items interfering with water drainage. See Care and Cleaning - Pump Filter section for more information.

Appliance Communication

WiFi Connect

Your Combo is **GE Appliances WiFi Connect** enabled.

It is highly recommended that you connect your Combo to WiFi to download the latest software, receive periodic updates and benefit from many of the extended features available through the SmartHQ App. Many features for your Combo may require connection to the SmartHQ App.

Visit GEAppliances.com/connect and enter your model number to show you the proper steps to connect your appliance and to learn more about connected appliance features.

You may not need to know your MAC ID to initial connect your Combo to SmartHQ, but it can be found in the WiFi section of the Menu of your Combo.

WiFi Connectivity: For assistance with the appliance or the **ConnectPlus** network connectivity, please call GE Appliances at **800.220.6899**.

Scan here to get started.

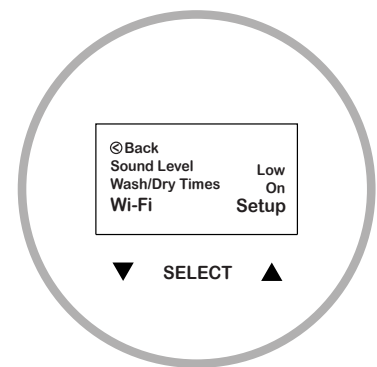

Loading

Always follow fabric manufacturer's care label when laundering.

Sorting Wash Loads

Sort by color (whites, lights, colors), soil level, fabric type (sturdy cottons, easy care, delicates) and whether the fabric produces lint (terry cloth, chenille) or collects lint (velveteen, corduroy). Wash lint producers such as cotton towels and socks separate from lint collectors including synthetic garments and dress pants.

⚠ WARNING  - Fire Hazard

- DO NOT** wash fabrics soiled with flammable liquids or cleaning solvents.
No washer can completely remove oil.
- DO NOT** dry anything that has been soaked in or spotted with any type of oil.
- DO NOT** reach into the unit until all moving parts have stopped.
- Doing so can result in death, explosion, fire or amputation.

Loading the Combo

The wash drum may be fully loaded with loosely added items.

To add items after the Combo wash has started, press **Start/Pause** and wait until the door is unlatched. The Combo may take up to 20 seconds to unlock the door after pressing **Start/Pause**, depending on the machine conditions. Do not try to force open the door when it is locked. After the door unlocks, open gently. Add items, close the door and press **Start/Pause** to restart.

Load Type	Mixed Load*	Towels & Sheets	Delicates**	Work Wear	Small Load (2-5 items)
Suggested Cycle	NORMAL	TOWELS	DELICATES	JEANS	QUICK CYCLE
Load Contents	<div style="border: 1px solid black; padding: 5px;"> * 6 Dress Shirts 3 Dress Pants 3 Poly T-Shirts 3 T-shirts 4 Pairs of Shorts 6 Boxers </div> <p style="text-align: center;">OR</p> 6 T-shirts 4 Sweatpants 4 Sweatshirts 2 Hoodies 7 Pairs of Socks	4 Pillowcases 2 Hand Towels 2 Flat Sheets/ 2 Fitted Sheets 2 Bath Towels/ 4 Washcloths <p style="text-align: center;">OR</p> 2 Flat Queen-Sized Sheets 2 Fitted Queen-Sized Sheets 4 Pillowcases	7 Bras 7 Panties 3 Slips 2 Camisoles 4 Nightgowns <p>**Using a nylon mesh bag for small items is recommended.</p>	4 Jeans 5 Work Shirts 3 Work Pants	1 Pair Casual Pants 2 Casual Shirts <p style="text-align: center;">OR</p> 3 Soccer Uniforms

*Used as the representative consumer 10-lb. Mixed Load to estimate the total cycle time of about two hours for the **Normal Wash + Dry** cycle with **Eco Dry** On. Individual results may vary based on actual load contents.

Care and cleaning

⚠ WARNING

Sharp Edges – Although it is unnecessary to perform this type of maintenance, to reduce the risk of injury, use care when cleaning the condenser or evaporator coil fins.

Exterior

Immediately wipe off any spills. Wipe or dust spills or washing compounds with a damp cloth. Combo control panel and finishes may be damaged by some laundry pretreatment and stain remover products. Apply these products away from the Combo. The fabric may then be washed and dried normally. Damage to your Combo caused by these products is not covered by your warranty. Do not hit surface with sharp objects.

Interior

Clean around the Combo's door opening, flexible gasket (including attached hoses) and door glass. These areas should always be clean to ensure a watertight seal. It is recommended to wipe down the gasket thoroughly with a disinfecting wipe to remove lint and other debris. A **Self Clean** Cycle can also be run for this purpose.

Filter Compartment

Periodically clean inside the filter compartment by removing the filter frame. Use either a vacuum with a crevice tool attachment or the Appliance Brush Set (Part # **PM14X10056**). When cleaning, be careful not to damage or bend the fins of the evaporator which is just inside the area to the right of the opening.

The Appliance Brush Set can be ordered through **GEApplianceparts.com**.

Filters

The filter compartment contains a two-stage housing consisting of a **Lint Filter** and a **Foam Filter**. To access the filters, slowly remove the filter frame from the Combo by pulling straight out and pressing on the tab to release.

Lint Filter: Clean the lint filter after every 5th dry cycle by running your fingers across it. A helpful reminder will show on the display. A waxy buildup may form on the lint filter from using fabric softener sheets. To remove this buildup, wash the lint filter in warm, soapy water. Dry thoroughly and replace.

Foam Filter: Clean the foam filter periodically (approximately every 50 cycles) or when notified by the Combo. Open the filter frame and remove the foam filter. Rinse filter and discard lint. Insert the foam filter back into the filter frame using the locating tabs for guidance. Ensure the filter is properly aligned in the frame.

NOTE: If the foam is torn or deformed do not reuse it. A replacement foam, part **WH01X35719**, can be ordered through **GEApplianceparts.com**.

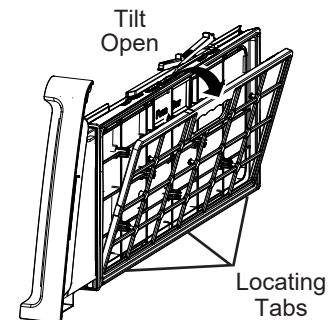
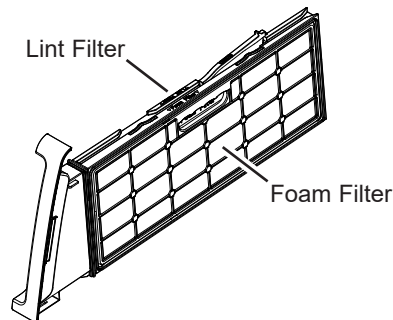
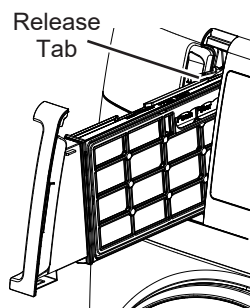

Vacuum the lint from the filter frame and inside the filter opening if you notice a change in dryer performance.

Your Combo will suggest when to clean the lint filter and foam filter.

NEVER OPERATE THE COMBO WITHOUT ITS FILTERS IN PLACE.

Care and cleaning

Self Clean

To clean the interior of the Combo, select the **SELF CLEAN** feature on the control panel. This **Self Clean** cycle should be performed, at a minimum, once per month or about every 40 cycles. This cycle will use more water, in addition to bleach which can be added as an option, to control the rate at which soils and detergents may accumulate in your Combo.



NOTE: Read the instructions below completely before starting **Self Clean** cycle.

1. Remove any garments or objects from the Combo and ensure the Combo's basket is empty.
2. Optional Step: Open the Combo door and pour one cup or 250 ml of liquid bleach or other washing machine cleaner into the basket.
3. Close the door and select the **SELF CLEAN** cycle. Push the **Start** button.
4. When the **Self Clean** cycle is working, the display will show the estimated cycle time remaining. The cycle will complete in about 50 minutes. Do not interrupt the cycle.

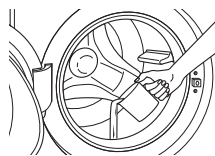

Following the **Self Clean**, the Combo will automatically run a 60 minute drying step to remove excess moisture from inside the Combo's interior. You can choose to cancel this drying step. Doing so will not impact the performance of **Self Clean**.

If for any reason the cycle needs to be interrupted, the door will not open immediately. Forcing open the door at this stage may cause water to flood. The door will open after the water is drained to a level where it would not flood the floor.

Self Clean may be interrupted by pressing the **Start/Pause** button during its operation. A power outage in the house might also interrupt the cycle. When the power supply is back, the **Self Clean** cycle resumes where it had stopped. When interrupted, be sure to run a complete **Self Clean** cycle before using the Combo. If the **Power** button is pressed during **Self Clean**, the cycle will be canceled.

IMPORTANT:

- Run **Self Clean** once a month.
- After the completion of a **Self Clean** cycle, the interior of your unit may have a strong "bleach smell" if you chose to use bleach to assist the **Self Clean**.
- It is recommended to run a **Rinse & Dry** or a light color load after the **Self Clean** cycle, if bleach was used.

Dispenser & Softener Drawer Areas

Detergent and fabric softener may build up in the dispenser drawers. Residue should be removed once or twice a month.

Perform this effort for each of the two drawers:

- Remove the drawer by first pulling it out until it stops. Then reach back into the rear of the drawer cavity and press down firmly on the lock tab, pulling out the drawer.
- Rinse the drawer with hot water to remove traces of accumulated laundry products.
- To clean the drawer opening, use a small brush to clean the recess. Remove all residue from the upper and lower parts of the recess.
- Replace the dispenser drawer.
- To reduce buildup in the detergent drawer area:

Use only HE
High-Efficiency
detergent

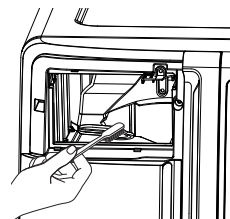
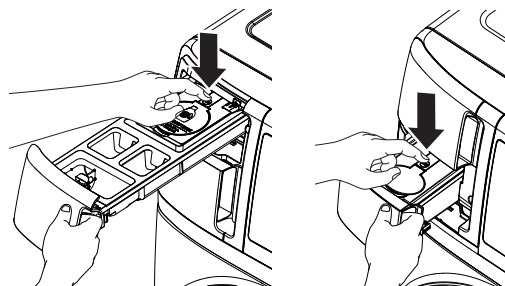

Care and cleaning

Pump Filter

Due to the nature of a front-load unit, it is sometimes possible for small articles to pass to the pump. The Combo has a filter to capture lost items and items that could cause clogs so they are not dumped into the drain. To retrieve lost items and to remove potentially trapped debris, clean out the pump filter.

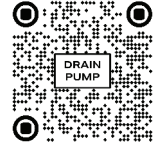

1. Using a small flathead screwdriver or coin, open the access door.
2. Place a shallow pan or dish under the pump access door and towels on the floor in front of the Combo to protect the floor. It is normal to catch about a cup of water when the filter is removed.
3. Pull down the pour spout.
4. Turn the pump filter counterclockwise and remove the filter slowly, controlling the flow of the draining water.
5. Remove the filter and clean the debris from the filter.
6. Replace the filter and turn clockwise. Tighten securely.
7. Flip up the pour spout.
8. Close the access door by hooking the bottom tabs first, then rotating the access door shut.



Door Gasket

Open the Combo door. Using both hands, press down the door gasket.

While holding down the door gasket, inspect the interior fold. Remove any foreign objects if found trapped inside this gasket.

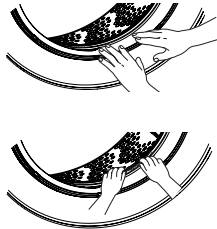

Make sure there is nothing blocking the holes behind the gasket.

When you are finished cleaning the door gasket, release it and the gasket will return to the operating position.



NOTE: It is highly recommended that you run the **Self Clean** per those instructions to ensure that the gasket is cleaned as part of that maintenance step.

Water Supply Hoses

Periodically inspect all water inlet hoses for water leaks, wear, cuts, corrosion, and bulges. Replace all hoses immediately if any sign of these failures appear. All hoses should be replaced every 5 years of use to reduce risk of hose failures and possible water damage. When replacing hoses, refer to the Installation Instructions for proper installation. **DO NOT** overtighten or cross thread fittings. **DO NOT** allow the hose to rub against sharp objects, become kinked, or become over stretched. Always ensure hose rubber gaskets are installed and free from leaks when pressurized.

Moving and Storage

Ask the service technician to remove water from drain pump and hoses. Do not store the Combo where it will be exposed to the weather. When moving the Combo, the tub should be kept stationary by using the shipping bolts removed during installation. See Installation Instructions in this manual. If these parts are not available, they can be ordered by visiting our Website at GEApplianceparts.com or by calling GE Appliances at 877.959.8688. In Canada, visit your local GE Appliances parts distributor or call 800.661.1616 or GEAppliances.ca/en/products/parts-filters-accessories.

Long Vacations

If you expect to not use your Combo for an extended period of time, make sure water supply is shut off at faucets. You may want to drain water from the inlet hoses and drain the pump filter especially if weather will be below freezing.

Troubleshooting Tips... Before you call for service

It is highly recommended that you connect your Combo to WiFi to download the latest software, receive periodic updates and benefit from many of the extended features available through the SmartHQ App. Many of the AI features for your Combo require connection to the SmartHQ App. This may resolve some issues listed below.

Problem	Possible Cause	What To Do
Not draining Not spinning Not tumbling	Load is out of balance	Redistribute clothes and run Rinse & Spin or Rinse & Dry . Increase load size if washing small load containing heavy and light items.
	Pump filter may be clogged	See the Care and Cleaning section on how to clean the Pump Filter .
	Drain hose is kinked or improperly connected	Straighten drain hose and make sure Combo is not sitting on it.
	Household drain may be clogged	Check household plumbing. You may need to call a plumber.
	Drain hose siphoning; drain hose pushed too far down the drain	Ensure there is an air gap between hose and drain. Also, ensure the drain hose is not inserted more than 7" into the drain pipe.
Leaking water	Door gasket is damaged	Check to see if gasket is seated and not torn. Objects (nails, screws, pens, pencils) left in pockets and clothes trapped between the door glass and the gasket may cause damage to the Combo. Water may drip from the door when the door is opened. This is a normal operation. Carefully wipe off rubber door seal and door glass. Sometimes dirt or clothing is left in this seal and can cause a small leak.
	Check back left of Combo for water	If this area is wet, you have oversudsing condition. Use less detergent.
	Fill hoses or drain hose is improperly connected	Make sure hose connections are tight at Combo and faucets and make sure end of drain hose is correctly inserted in and secured to drain facility.
	Household drain may be clogged	Check household plumbing. You may need to call a plumber.
	Dispenser clogged	Powder soap may cause clogs inside the dispenser and cause water to leak out the front of the dispenser. Remove drawer and clean both drawer and inside of dispenser box. Laundry detergent packets should NOT be used in the dispenser. They should only be added directly to the wash basket following the manufacturer's directions. Please refer to Care and Cleaning section.
	Incorrect use of detergent	Use only HE and correct amount of detergent.
	Dispenser box cracked	If new installation, check for crack on inside of dispenser box.
Clothes too wet	Load is out of balance	Redistribute clothes and run Rinse & Dry .
		Increase load size if washing small load containing heavy and light items.
		The machine will slow the spin speed down to 410 rpm if it has a hard time balancing the load. This speed is normal.
	Pump filter may be clogged	See the Care and Cleaning section on how to clean the Pump Filter .
	Overloading	The dry weight of the load should be less than 20 lbs.
	Drain hose is kinked or improperly connected	Straighten drain hose and make sure the Combo is not sitting on it.
	Household drain may be clogged	Check household plumbing. You may need to call a plumber.
Drain hose siphoning; drain hose pushed too far down the drain	Ensure there is an air gap between hose and drain. Also, ensure the drain hose is not inserted more than 7" into the drain pipe.	

Troubleshooting Tips... Before you call for service

Problem	Possible Cause	What To Do
Incomplete cycle or timer not advancing	Automatic load redistribution	Timer adds up to 3 minutes to cycle for each rebalance. 11 or 15 rebalances may be done. This is normal operation. Do nothing; the machine will finish the cycle.
	Pump filter may be clogged	See the Care and Cleaning section on how to clean the Pump Filter .
	Drain hose is kinked or improperly connected	Straighten drain hose and make sure the Combo is not sitting on it.
	Household drain may be clogged	Check household plumbing. You may need to call a plumber.
	Drain hose siphoning; drain hose pushed too far down the drain	Ensure there is an air gap between hose and drain. Also, ensure the drain hose is not inserted more than 7" into the drain pipe.
Loud or unusual noise; vibration or shaking	Cabinet moving	The Combo is designed to move 1/4" to reduce forces transmitted to the floor. This movement is normal.
	All rubber leveling legs are not firmly touching the floor	Push and pull on the back right and then front left of your Combo to check if it is level. If the Combo is uneven, or rocks excessively during operation, adjust the rubber leveling legs so they are all firmly touching the floor and the lock nuts are tightened to the base of the Combo.
	Unbalanced load	Pause the Combo, open door and manually redistribute load. To check machine, run rinse and spin with no load. If normal, unbalance was caused by load.
	Pump filter may be clogged	See the Care and Cleaning section on how to clean the Pump Filter .
No power/Combo not working or dead	The Combo is unplugged	Make sure cord is plugged securely into a working outlet.
	Water supply is turned off	Turn both hot and cold faucets fully on.
	Circuit breaker/fuse is tripped/blown	Check house circuit breakers/fuses. Replace fuses or reset breaker. The Combo should have a separate outlet.
	Automatic self system checks	First time the Combo is plugged in, automatic checks occur. It may take up to 20 seconds before you can use your Combo. This is normal operation.
"Confirm H2O Supply is ON" appears in display	Water not entering the Combo	See the Consumer Help Indicator section for details.
"Cycle Canceled Draining" appears in display	The Combo paused or stopped	See the Consumer Help Indicator section for details.
"DOOR OPEN" appears in display	Door not fully closed	See the Consumer Help Indicator section for details.
"Check and Clean Drain Pump Filter" appears in display	Restriction in the drain area	See the Consumer Help Indicator section for details.

Troubleshooting Tips... Before you call for service

Problem	Possible Cause	What To Do
Snags, holes, tears, rips or excessive wear	Overloaded	Do not exceed maximum recommended load sizes. See recommended maximum load sizes in the Loading section.
	Pens, pencils, nails, screws or other objects left in pockets	Remove loose items from pockets.
	Pins, snaps, hooks, sharp buttons, belt buckles, zippers and sharp objects left in pockets	Fasten snaps, hooks, buttons and zippers.
Control time wrong or changes	This is normal	During spin the Combo may need to rebalance the load sometimes to reduce vibrations. When this happens, the estimated time is increased causing time left to increase or jump. Also, in Sensor Dry , the time may be extended to allow sufficient time for the load to fully dry.
Not enough water	This is normal	Horizontal units do not require the tub to fill with water like top-load units.
Combo pauses or has to be restarted, or Combo door is locked and will not open	Pump filter may be clogged	See the Care and Cleaning section on how to clean the Pump Filter .
Door unlocks or press Start and machine doesn't operate	This is normal	Front-load units start up differently than top-load units, and it takes several seconds to check the system. The door will lock and unlock. The Combo also will run a Load Sense at the start before filling with water and commencing the wash portion of the cycle.
	Incorrect operation	Simply open and close the door firmly; then press Start .
	Control Lock On	Press and hold the Control Lock button for 3 seconds.
Water does not enter Combo or enters slowly	Automatic self system checks	After Start is pressed, the Combo does several system checks. Water will flow several seconds after Start is pressed.
	Water valve screens are clogged	Turn off the water source and remove the water connection hoses from the upper back of the Combo. Use a brush or toothpick to clean the screens in the machine. Reconnect the hoses and turn the water back on.
	Inlet hose screen washers are clogged	Turn off the water source and remove the inlet hoses from the wall faucets. Use a brush or toothpick to clean the screen washers in the end of the hoses. Reconnect the hoses and turn the water back on.
	Pump filter may be clogged	See the Care and Cleaning section on how to clean the Pump Filter .
	Fill hoses may be kinked	Check that fill hoses are not kinked or clogged.
	Water supply is turned off	Turn on both hot and cold faucets fully.
	Insufficient water supply	Make sure that the water supply is turned on. Make sure that the water faucets are turned to their completely open position.
	The Combo door is open	The Combo's door must be closed for all cycle operations. If the door is opened during the Combo's operation, all functions will stop, including water filling.
	Incorrect fill hose connection	Make sure that the fill hoses connect the hot water supply to the hot inlet on the Combo and the cold water supply to the cold inlet on the Combo (HOT to HOT and COLD to COLD).

Troubleshooting Tips... Before you call for service

Problem	Possible Cause	What To Do
Wrinkling	Improper sorting	Avoid mixing heavy items (like work clothes) with light items (like blouses).
	Overloading	Load your Combo so clothes have enough room to move freely.
	Incorrect cycle	Match cycle selection to the type of fabric you are washing (especially for easy care loads).
	Repeated washing in water that is too hot	Wash in warm or cold water.
Grayed or yellowed clothes	Not enough detergent	Use correct amount of detergent.
	Not using HE (high efficiency) detergent	Use only HE detergent.
	Hard water	Use hottest water safe for fabric.
		Use a water conditioner like Calgon brand or install a water softener.
	Water is not hot enough	Make sure water heater is delivering water at 120°–140°F (48°–60°C).
	Detergent is not dissolving or using too much fabric softener	Try a liquid HE detergent. Use less fabric softener.
Dye transfer	Sort clothes by color. If fabric label states wash separately, unstable dyes may be indicated.	
Colored spots	Incorrect use of fabric softener	Check fabric softener package for instructions and follow directions for using dispenser.
	Dye transfer	Sort whites or lightly colored items from dark colors.
		Promptly remove wash load from the Combo.
Water temperature is incorrect	Water supply is improperly connected	Make sure hoses are connected to correct faucets (HOT to HOT and COLD to COLD).
	House water heater is not set properly	Make sure house water heater is delivering water at 120°–140°F (48°–60°C).
Bad odor inside your Combo	Combo unused for a long time, not using HE detergents or using too much detergent	Regularly use a Dry cycle option.
		In case of strong odor, you may need to run the Self Clean cycle more than once.
		Use only the amount of detergent recommended or adjust SmartDispense to LOW .
		Use only HE (high efficiency) detergent.
		Always remove wet items from the Combo promptly after it stops running.
		If you choose to not use a Dry cycle option, leave the door slightly open for the Combo to air dry. Close supervision is necessary if this appliance is used by or near children. Do not allow children to play on or in this appliance.
	There is residual lint, etc. in the drain pump filter which should be cleaned	See the Care and Cleaning section on how to clean the Pump Filter .
Drain hose pushed too far down the drain	See the Installation Instructions section for proper installation.	
Detergent begins to slowly dispense into tub	This is normal	It is normal operation to see detergent leak on door gasket about 20 seconds after filling the dispenser. Ensure the dispenser drawer is fully closed.

Troubleshooting Tips... Before you call for service

Problem	Possible Cause	What To Do
Improper dispensing of softener or bleach	Dispenser clogged	Monthly clean the dispenser drawer to remove buildup of chemicals.
	Softener or bleach is filled above the max line	Make sure to have the correct amount of softener.
Dispenser drawer not dispensing properly	Laundry detergent packet placed in dispenser drawer	Laundry detergent packets should NOT be used in the dispenser. They should only be added directly to the wash basket following the manufacturer's directions.
Pump running while Combo is not in use	Clog in sump drain	Drain sump is detecting an undesired water fill level from a potential open faucet. Shut off water valve and inspect water valve for blockage. Ensure you have the latest updates for your Combo available through the SmartHQ App.
Clothes take too long to dry	Improper sorting	Separate heavy items from lightweight items (generally, a well-sorted washer load is a well-sorted dryer load).
	Large loads of heavy fabrics (like beach towels)	Large, heavy fabrics contain more moisture and take longer to dry. Separate large, heavy fabrics into smaller loads to speed drying time.
	Lint filter is full	Clean the lint filter after every 5th dry cycle.
	Eco Dry is OFF or More Dry is ON	By turning off Eco Dry and adding More Dry , the Combo will dry clothes to a higher dryness level than what may be required. Consider running with More Dry off. If you desire even shorter time you can turn Eco Dry on in the menu. You may need to find the best conditions for your acceptable dryness level.
Time Remaining changes or inconsistent dry times	The estimated time may change when the sensors detect that optimal dryness has not been met	The time remaining in drying adjusts based on humidity checks made by your smart Combo during the drying portion of the cycle. You may notice these adjustments at the start of drying, during drying or the final minutes of drying.
	Type of load and drying conditions	The load size, types of fabric, wetness of clothes and the length and condition of the exhaust system will affect drying times.
Clothes are still damp even though the Combo completed the cycle	The Combo was paused mid-cycle and never restarted	The door may have been opened mid-cycle and the cycle not restarted. A dry cycle must be re-selected to complete the drying process.
	Load was already dry except for collars and waistbands	Start a TIMED DRY to dry damp collars and waistbands. In the future, when drying a load with collars and waistbands, choose More Dry .
	This is normal	Because your Combo dries clothes at a consistent temperature in a sealed drum, they may not feel as dry or as warm on first touch. Just take them out and they will feel dry in a few seconds.
Clothes are wrinkled	Letting items sit in the Combo after cycle ends	Remove items when cycle ends and fold or hang immediately, or use the Wrinkle Care option.
	Overloading	Separate large loads into smaller ones. Load fewer garments; manually increase time.
Combo continues to tumble after display says Complete	Wrinkle Care was selected	Ensure Wrinkle Care option is not selected.
Water drips from door when opened	Some residual water from the dispenser drips down into the gasket	Water from the dispenser may drip down into the gasket when the door is first opened. This is normal. You may want to wait a few seconds before retrieving clothes.
Heat generated by the Combo	This is normal	Some heat is generated by the sealed system located at the top of the unit. This is normal operation.
Small items trapped in the door that do not dry	Items are plastered during high speed spin or get pushed between gasket and glass	Use a nylon mesh bag for small items that may become trapped between the door glass and gasket and do not fully dry.